

IRCOB9-2827-840-60-001

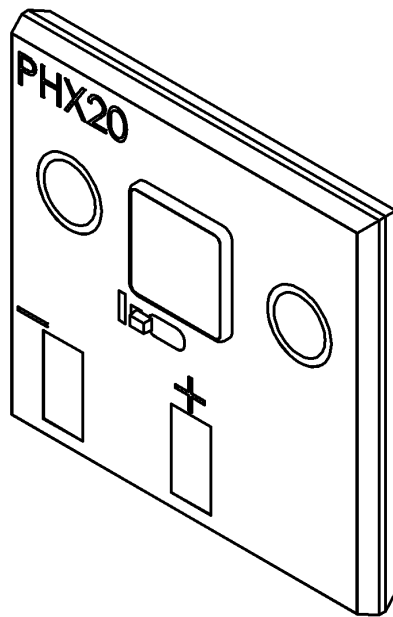

IRCOB9-2827-840-60-001

840nm HIGH POWER LED



Features

- Chip size : 1.0×1.0mm
- Number of Chips : 9pcs
- Peak Wavelength : 840nm
- Optical efficiency (typ.) : 6500mW
- Viewing half angle : 60°
- Package : Copper substrate
- Lens : Silicone Resin

Applications

- Machine Vision System
- Light source for in-vehicle camera
- Infrared data communication

IRCOB9-2827-840-60-001

Maximum Ratings (Tc=25°C)

Parameter	Symbol	Values	Unit
Power Dissipation	P_D	34.2	W
Forward Current	I_F	9	A
Reverse Voltage	V_R	5	V
Junction Temperature	T_j	115	°C
Operating Temperature	T_{opr}	-40~85	°C
Storage Temperature	T_{stg}	-40~85	°C
Thermal Resistance	R_{thja}	1	K/W

※Soldering condition : Soldering condition must be completed with 10 seconds at below 260°C

Optical and Electrical Characteristics (Tc=25°C)

Parameter	Symbol	Min	Typ	Max	Unit	Test Condition
Forward Voltage	V_F		3.3	3.8	V	$I_F=9A$
Radiated Power	P_O		6500		mW	$I_F=9A$
Peak Wavelength	λ_p		840		nm	$I_F=9A$
Half Width	$\Delta \lambda$		35		nm	$I_F=9A$
Viewing Half Angle	$\theta_{1/2}$		± 60		deg	$I_F=1A$

Typical Characteristic Curves

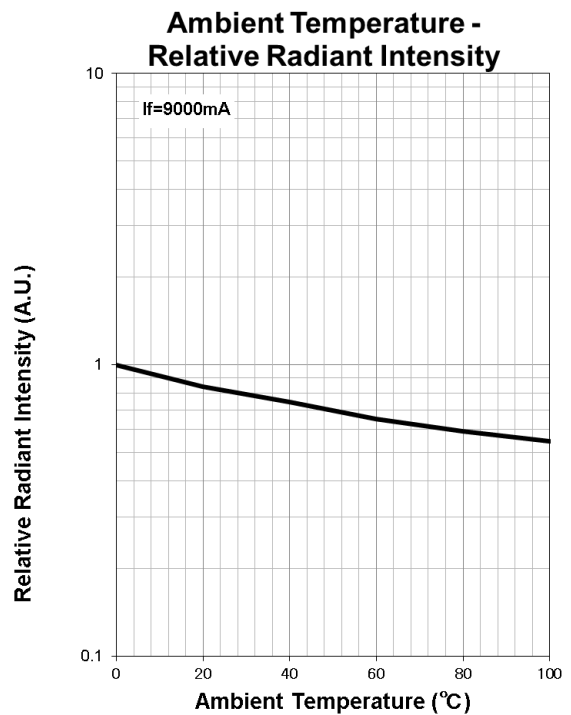
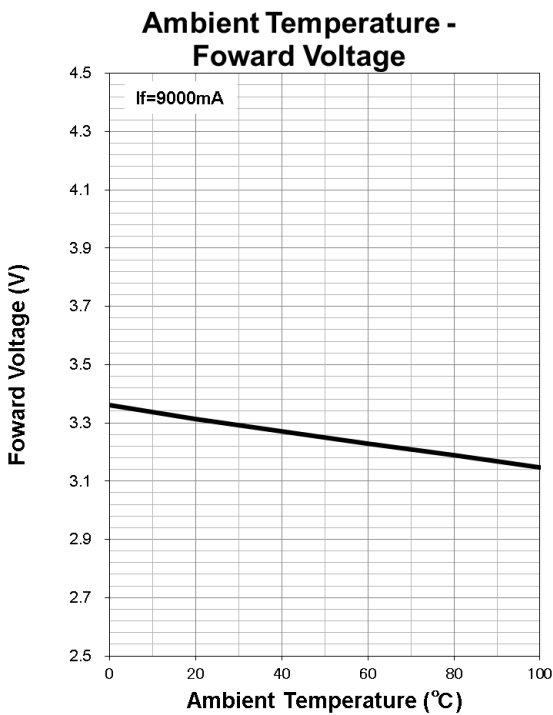
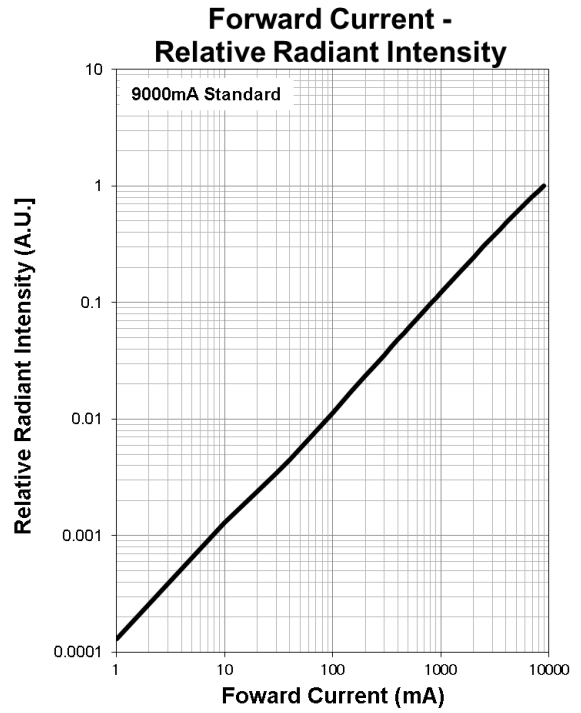
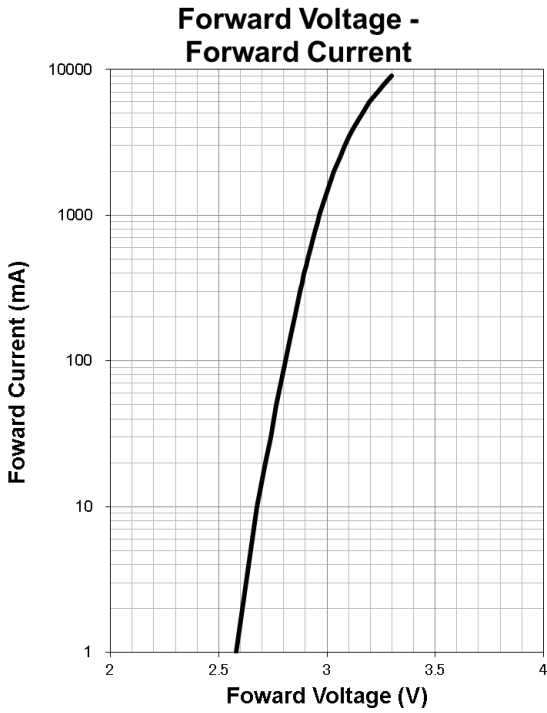

Ambient Temperature - Peak Wavelength

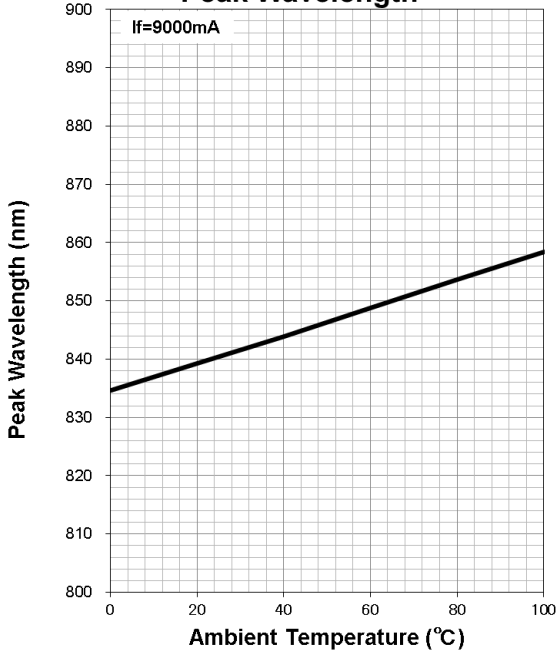

Radiation Characteristics

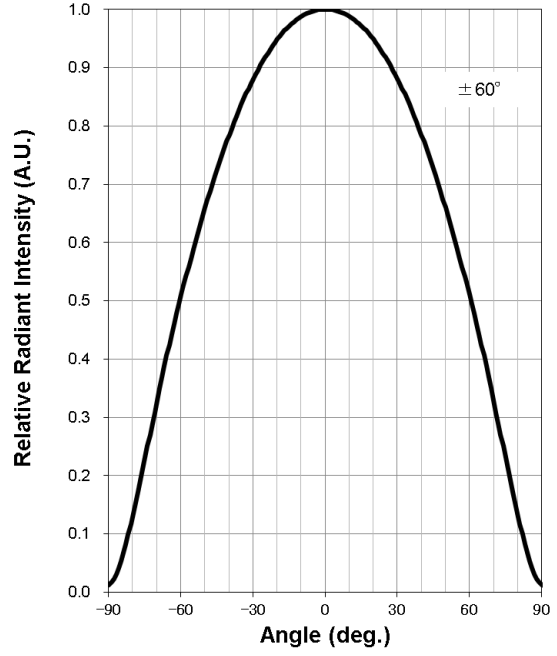

Ambient Temperature - Allowable Forward Current

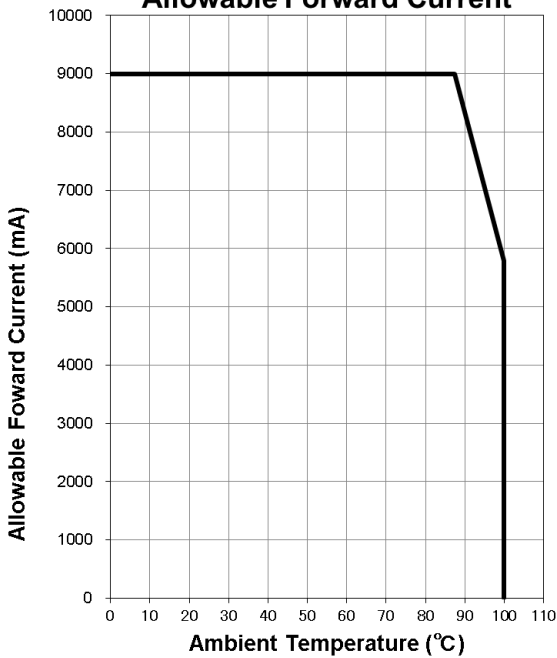

IRCOB9-2827-840-60-001

Outline

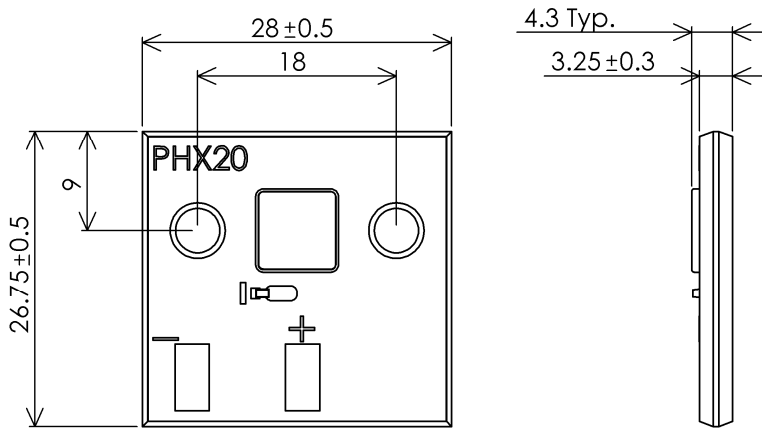

Mar. 2018