

IRSMD5050-780-60-001

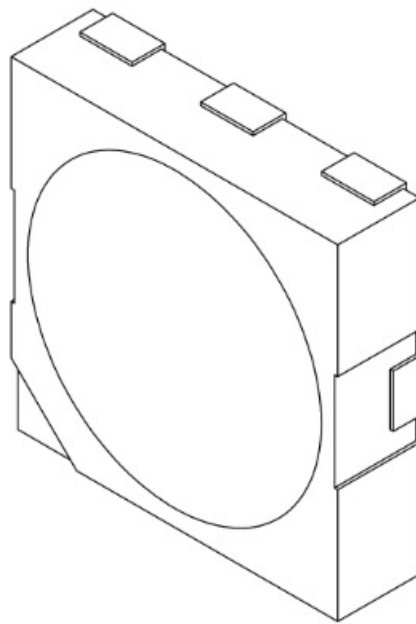

IRSMD5050-780-60-001

780nm HIGH POWER LED



Features

- Chip size : 1.0×1.0mm
- Number of Chips : 1pc
- Peak Wavelength : 785nm
- Optical efficiency (typ.) : 880mW
- Viewing half angle : 60°
- Package : SMD Resin package
- Lens : Silicone Resin

Applications

- Machine Vision System
- Light source for in-vehicle camera
- Infrared data communication

IRSMD5050-780-60-001

Maximum Ratings (Tc=25°C)

Parameter	Symbol	Values	Unit
Power Dissipation	P_D	4000	mW
Forward Current	I_F	1000	mA
Pulse Forward Current	I_{FP}	3000	mA
Reverse Voltage	V_R	5	V
Junction Temperature	T_j	115	°C
Operating Temperature	T_{opr}	-40~100	°C
Storage Temperature	T_{stg}	-40~100	°C
Thermal Resistance	R_{thja}	10	K/W

※Pulse Forward Current Condition : Duty 1% and Pulse Width=10us.

※Soldering condition : Soldering condition must be completed with 5 seconds at below 260°C

Optical and Electrical Characteristics (Tc=25°C)

Parameter	Symbol	Min	Typ	Max	Unit	Test Condition
Forward Voltage	V_F		3.5	4.0	V	$I_F=1A$
	V_{FP}		4.2		V	$I_{FP}=3A$
Radiated Power	P_O		880		mW	$I_F=1A$
			2730		mW	$I_{FP}=3A$
Radiant Intensity	I_E		993		mW/sr	$I_F=1A$
			3100		mW/sr	$I_{FP}=3A$
Peak Wavelength	λ_p		780		nm	$I_F=1A$
Half Width	$\Delta \lambda$		19		nm	$I_F=1A$
Viewing Half Angle	$\theta_{1/2}$		±60		deg	$I_F=100mA$

※Radiated Power is measured by S3584-08.

※Radiant Intensity is measured by CIE127-2007 Condition B.

Typical Characteristic Curves

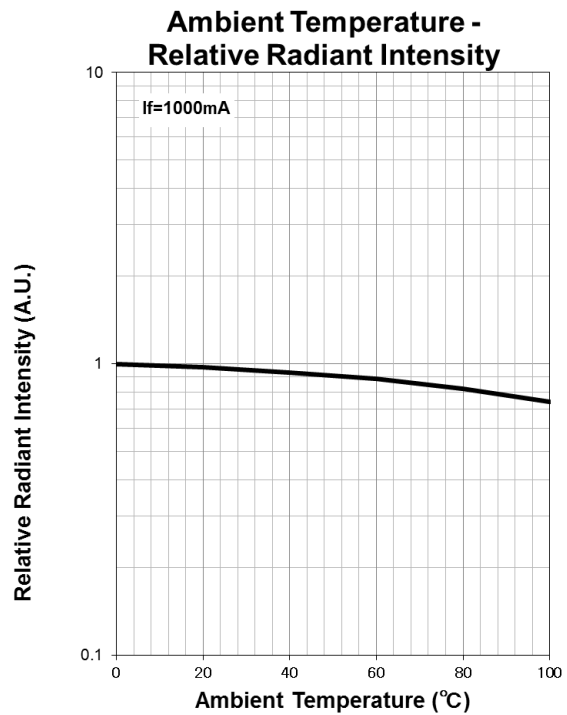
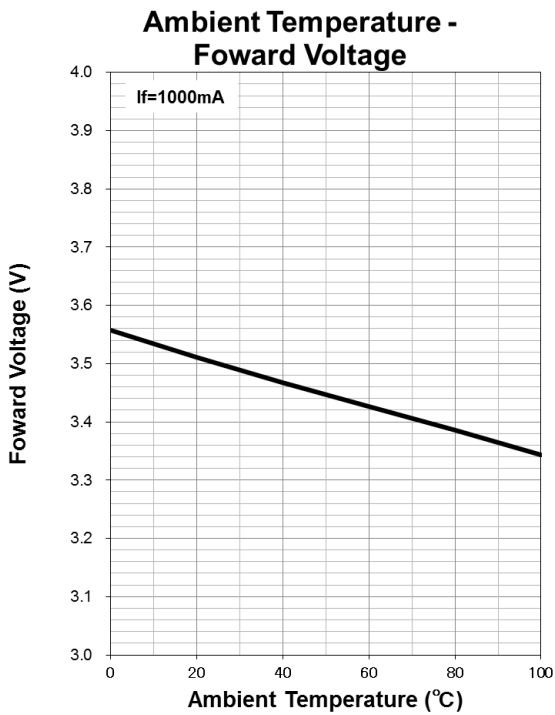
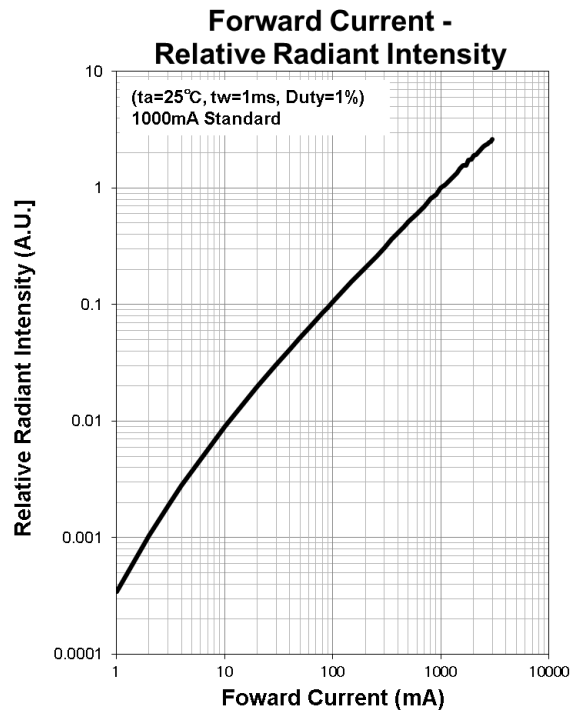
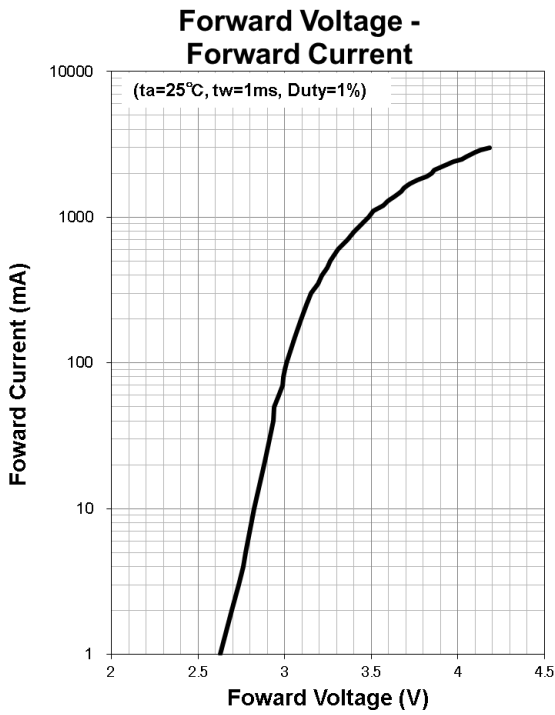

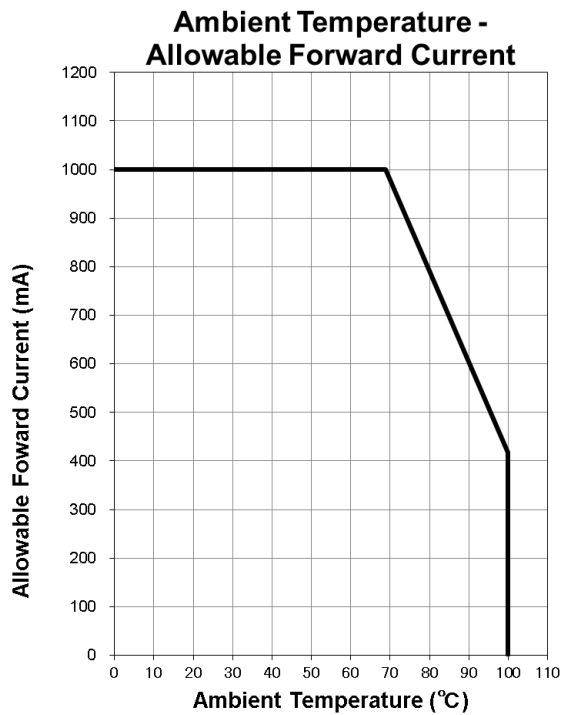
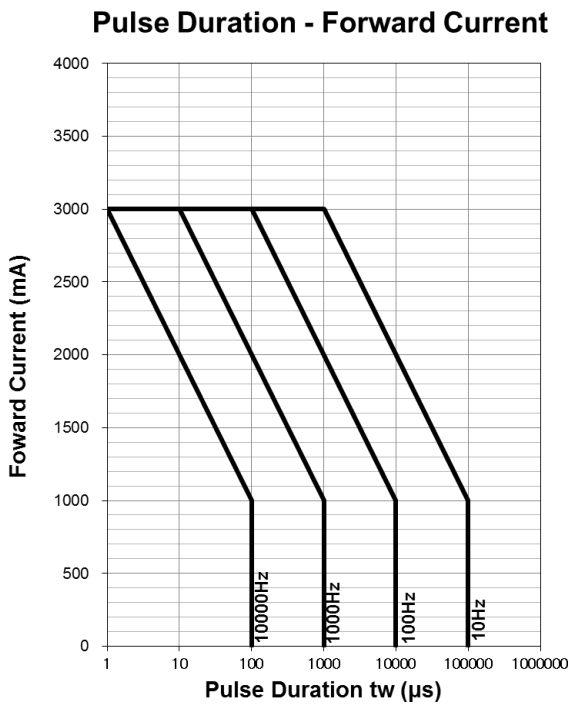
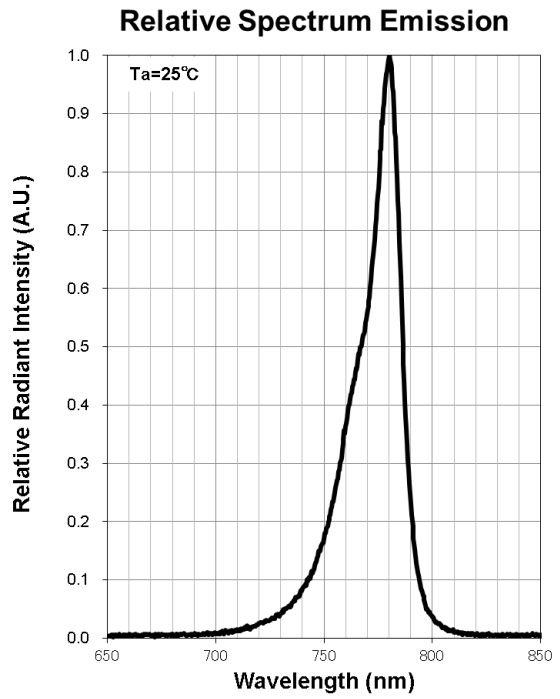
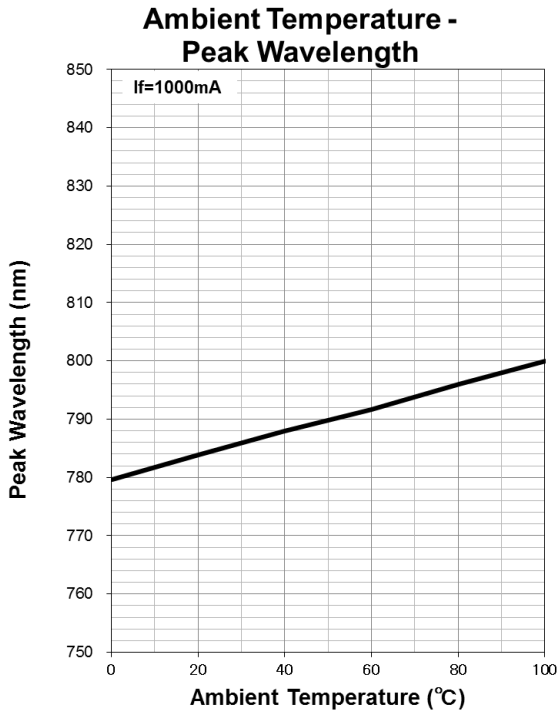

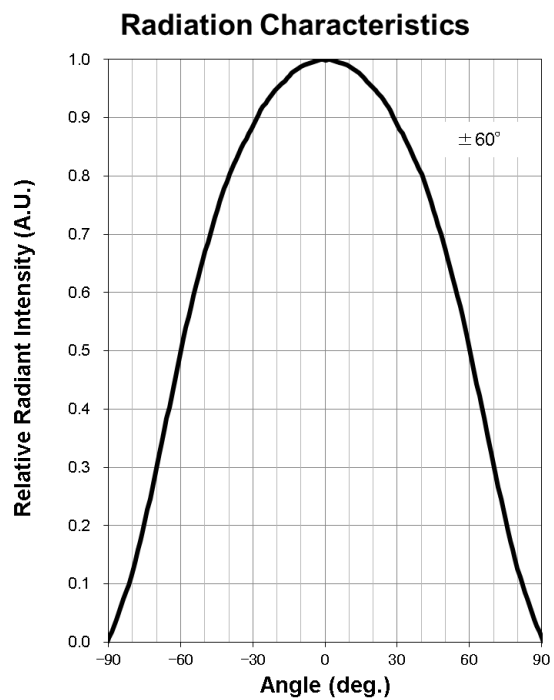

IRSMD5050-780-60-001

Outline and Internal Circuit

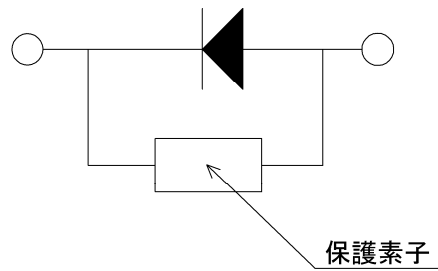
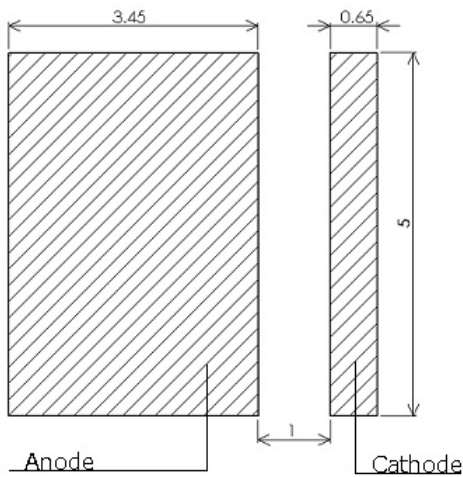
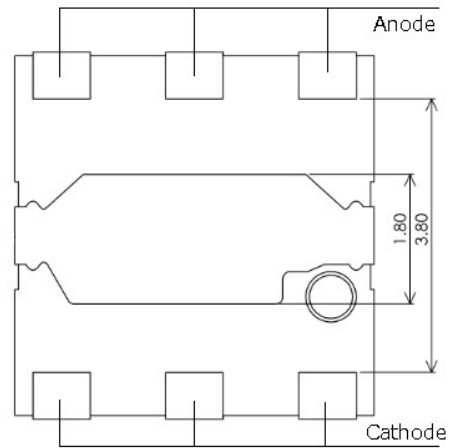
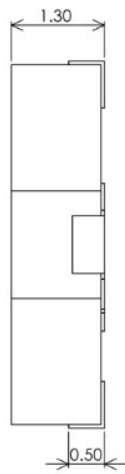
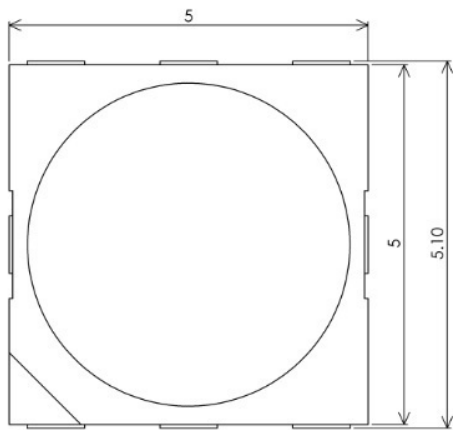

IRSMD5050-780-60-001

RECOMMENDED METHODE OF STORAGE AND HANDLING**Storage Conditions****Before opening the moisture-proof Aluminum Bag**

- Please keep at the condition of < 30°C and < 60% RH
- The maximum storage life is 12 months under these conditions.

After opening the moisture-proof Aluminum Bag

- Please store the aluminum bag and silica gel in a drying apparatus.
- The LED should go through the soldering process within 72 hours in a room with the condition of 5~30°C and < 50% RH.
- Unused remaining LEDs and silica gel should be returned to the original aluminum bag. And please hermetically seal that bag.
- It is recommended to store the re-sealed bag in a drying apparatus at the condition of < 30% RH.
- 72 hours of long floor life does not included the time period which LEDs are stored in the moisture-proof Aluminum Bag. Even though, it is highly recommended to solder the LEDs as soon as after opening the aluminum bag.

Disclaimer

Phoenix Electric Co., Ltd. reserves the right to change product specifications and data in this brochure without notice. Product performance, reliability, appearance or aspects might be changed according to its improvement.

Product data and parameters in this brochure are typical values according to reasonably updated measurements.

Product data and parameters may vary by its application and operating time.

Products listed in this brochure are designed for the application of general electronic equipment or apparatus. Products are not designed for the applications of airplanes, aerospace equipment, automobiles, traffic control systems, nuclear power control systems, medical devices, safety devices and any other applications in which malfunction or failure may result in personal injury or death.

Oct. 2018